

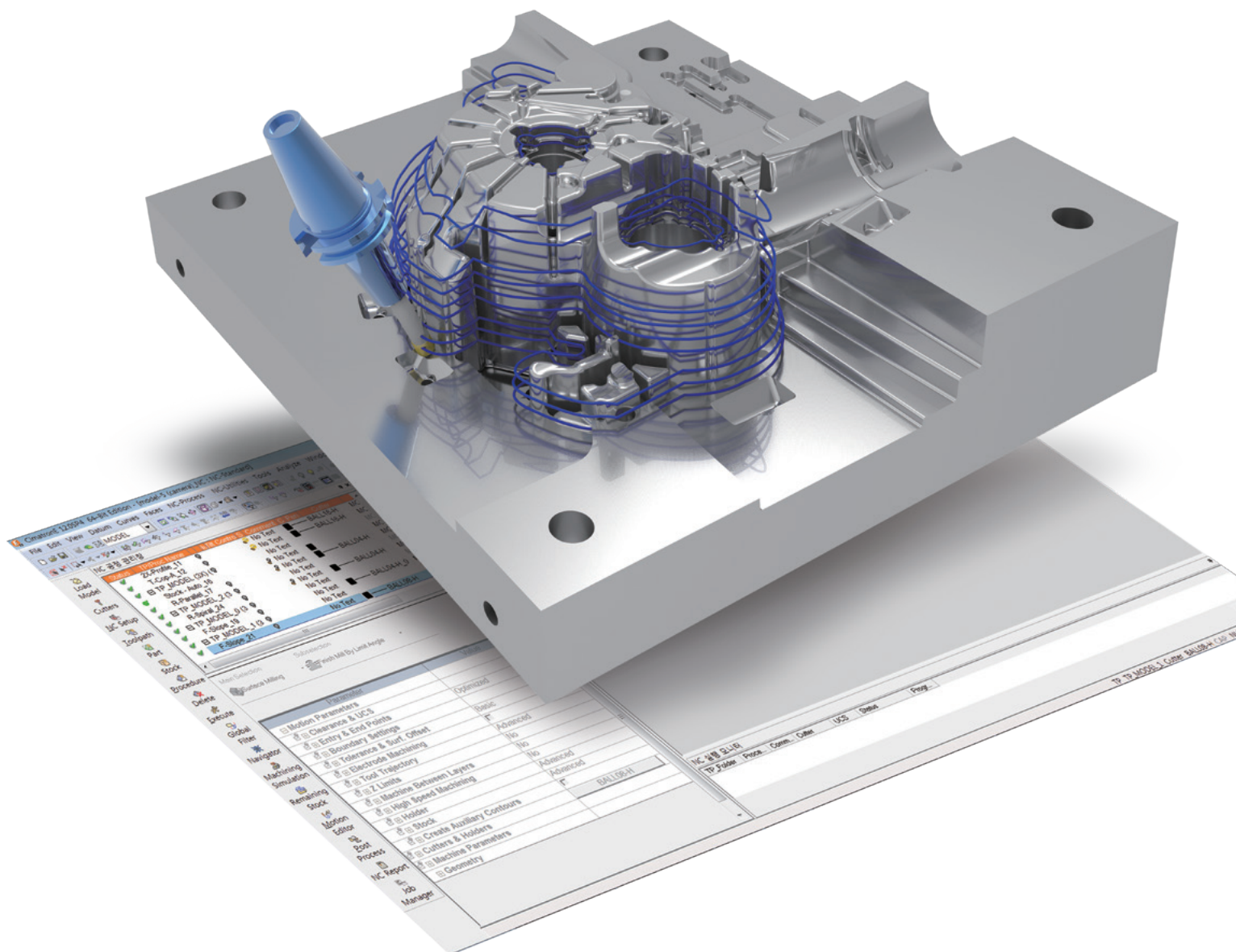

# NC Programming for Molds, Dies, Plates & Discrete Manufacturing



## Programming of multi-axis, high quality parts of any complexity

- Machine parts faster with confidence while protecting machines & tools
- Program toolpaths easier & faster with “Flexible automation”
- Prepare parts for manufacturing with full built-in CAD capabilities
- Use dedicated strategies to machine differing part types

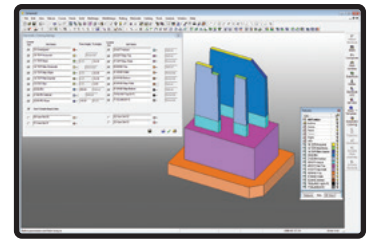

## Fast Programming, Effective Toolpaths

- Control over machining process with NC Setup, immediate stock review, and Job Manager.
- Rapid programming with customized NC templates and fast calculation using multi threads, background execution, and calculation on another PC.
- Creation of efficient and safe toolpaths with analysis, preview and simulation.
- Automated and customized NC reports with 3D images, dimensions and notes (PMI).

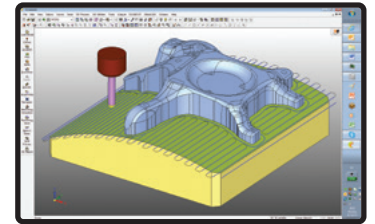

## Efficient Roughing, High Quality Finishing

- Powerful roughing, with ultra-high material removal rate all-rounded roughing (VoluMill).
- Superior surface quality with rich 3-5-axis finish, cleanup and rest material strategies, including air extensions and elimination of waterfalls.
- Multi-directional 3D mesh stock for 5-axis positioning efficient, collision-free toolpaths.
- Dedicated functionality for electrodes and micro milling.

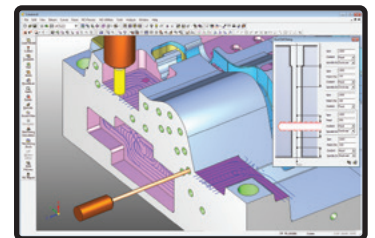

## Plate Machining Seat and Automated Drilling

- Manufacturing Feature Recognition (MFR) tool automatically recognizes Pocket's heights, shape and draft angle for safer and faster programming.
- A 2.5 axis Rough Pocket procedure handles open and closed pockets, supports HSM options (i.e. round motions) and delivers holder collision avoidance.
- Ultra-high material removal rate pocketing (VoluMill), with open pockets and 2D cleanup.
- Automated pocket and profile using surfaces with criteria-driven templates.
- Save 90% programming time with auto drill, including hole and actual stock recognition.
- Safe gun drilling, with all feed/speed parameters recognizing intersected drilled holes.

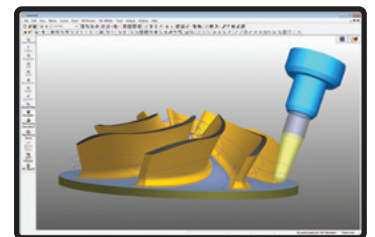

## 5-Axis Programming for Part Production

- Safely complete any job with full user control over 5-axis roughing and finishing.
- Time-saving applications for blades, impellers, blisks, ports, inlets and turbines.
- 5-axis machine and material removal simulation for medical, aerospace, and other complex parts.
- Access to a rich library of proven posts for any 5-axis machine and controller.

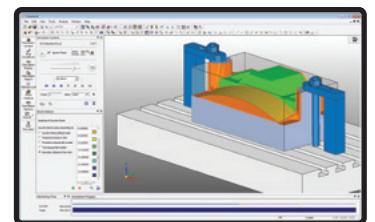

## Simulation and Verification for Confident Machining

- Machine simulation with true representation of the kinematics, work piece and fixtures.
- High quality embedded multi-axis material removal simulation.
- Reliable collision and gouge detection for machine, fixtures, stock, part, tool and holder.
- Toolpath verification with gouge and collision reports and color-coded remaining stock.

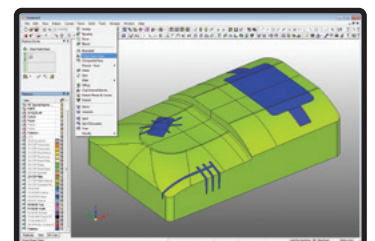

## Powerful CAD for NC with Reliable Data Import

- Repair the model and apply drafts and rounds with a hybrid CAD environment.
- Dedicated features for capping holes and slots, and extending surfaces.
- Import data from all standard and native formats, e.g. AutoCAD, Inventor, Catia, Creo, NX, and SolidWorks.